



Dell™ Inspiron™ 9300 Service Manual

Before You Begin	Speakers
System Components	Subwoofer
Optical Drive	USB Port Board
Hard Drive	Microprocessor Thermal-Cooling Assembly
Memory Module	Microprocessor Module
Modem	Video Card/Thermal Cooling Assembly
Mini PCI Card	System Fans
Internal Card With Bluetooth® Wireless Technology	MCH Heat Sink
Hinge Cover	PC Card Cage
Keyboard	System Board
Display	Battery Latch Assembly
Palm Rest	Flashing the BIOS
Coin-Cell Battery	Pin Assignments for I/O Connectors

Notes, Notices, and Cautions

-  **NOTE:** A NOTE indicates important information that helps you make better use of your computer.
-  **NOTICE:** A NOTICE indicates either potential damage to hardware or loss of data and tells you how to avoid the problem.
-  **CAUTION:** A CAUTION indicates a potential for property damage, personal injury, or death.

Abbreviations and Acronyms

For a complete list of abbreviations and acronyms, see the *Dell Inspiron Help* file. To access the help file, click the **Start** button, click **Help and Support**, click **User and system guides**, click **User's guides**, and click **Dell Inspiron Help**.

If you purchased a Dell™ n Series computer, any references in this document to Microsoft® Windows® operating systems are not applicable.

Information in this document is subject to change without notice.
© 2005 Dell Inc. All rights reserved.

Reproduction in any manner whatsoever without the written permission of Dell Inc. is strictly forbidden.

Trademarks used in this text: *Dell*, the *DELL* logo, and *Inspiron* are trademarks of Dell Inc.; *Microsoft* and *Windows* are registered trademarks of Microsoft Corporation; *Bluetooth* is a registered trademark owned by Bluetooth SIG, Inc. and is used by Dell Inc. under license.

Other trademarks and trade names may be used in this document to refer to either the entities claiming the marks and names or their products. Dell Inc. disclaims any proprietary interest in trademarks and trade names other than its own.

Model PP14L

February 2005 Rev. A00

[Back to Contents Page](#)

Before You Begin

Dell™ Inspiron™ 9300 Service Manual

- [Recommended Tools](#)
- [Turning Off Your Computer](#)
- [Before Working Inside Your Computer](#)
- [Computer Orientation](#)
- [Screw Identification](#)

This section provides procedures for removing and installing the components in your computer. Unless otherwise noted, each procedure assumes that the following conditions exist:

- 1 You have performed the steps in "[Turning Off Your Computer](#)" and "[Before Working Inside Your Computer](#)."
 - 1 You have read the safety information in the Dell™ *Product Information Guide*.
 - 1 A component can be replaced or—if purchased separately—installed by performing the removal procedure in reverse order.
-

Recommended Tools

The procedures in this document may require the following tools:

- 1 Small flat-blade screwdriver
 - 1 Phillips screwdriver
 - 1 Small plastic scribe
 - 1 Flash BIOS update program CD
-

Turning Off Your Computer

🔔 **NOTICE:** To avoid losing data, save and close any open files and exit any open programs before you turn off your computer.

1. Shut down the operating system:
 - a. Save and close any open files, exit any open programs, click the **Start** button, and then click **Turn Off Computer**.
 - b. In the **Turn off computer** window, click **Turn off**.

The computer turns off after the operating system shutdown process finishes.

2. Ensure that the computer and any attached devices are turned off. If your computer and attached devices did not automatically turn off when you shut down your operating system, press and hold the power button for 4 seconds.
-

Before Working Inside Your Computer

Use the following safety guidelines to help protect your computer from potential damage and to help ensure your own personal safety.

⚠ **CAUTION:** Before you begin any of the procedures in this section, follow the safety instructions in the *Product Information Guide*.

🔔 **NOTICE:** Handle components and cards with care. Do not touch the components or contacts on a card. Hold a card by its edges or by its metal mounting bracket. Hold a component such as a processor by its edges, not by its pins.

🔔 **NOTICE:** Only a certified service technician should perform repairs on your computer. Damage due to servicing that is not authorized by Dell is not covered by your warranty.

🔔 **NOTICE:** When you disconnect a cable, pull on its connector or on its strain-relief loop, not on the cable itself. Some cables have a connector with locking tabs; if you are disconnecting this type of cable, press in on the locking tabs before you disconnect the cable. As you pull connectors apart, keep them evenly aligned to avoid bending any connector pins. Also, before you connect a cable, ensure that both connectors are correctly oriented and aligned.

🔔 **NOTICE:** To avoid damaging the computer, perform the following steps before you begin working inside the computer.

1. Ensure that the work surface is flat and clean to prevent the computer cover from being scratched.
2. [Turn off your computer](#).

🔔 **NOTICE:** To disconnect a network cable, first unplug the cable from your computer and then unplug it from the network device.

3. Disconnect any telephone or network cables from the computer.
4. Disconnect your computer and all attached devices from their electrical outlets.
5. Close the display and turn the computer upside down on a flat work surface.

NOTICE: To avoid damaging the system board, you must remove the main battery before you service the computer.

6. Slide the battery-bay latch release on the bottom of the computer and remove the battery from the bay.
7. Turn the computer top-side up.

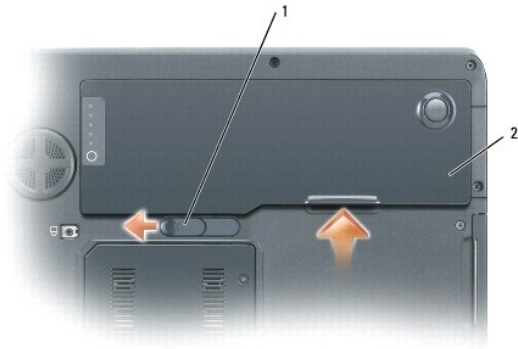

1	battery-bay latch release
2	battery

8. Remove any installed PC Cards from the PC Card slot.

Computer Orientation









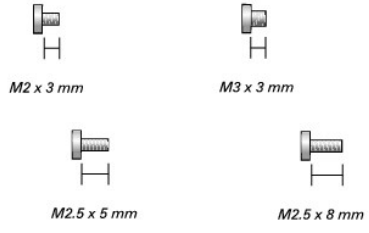







1	front
2	left
3	back
4	right

Screw Identification

When you are removing and replacing components, print "[Screw Identification](#)" as a tool to lay out and keep track of the screws. The placemat provides the number of screws and their sizes.



<p>Optical Drive: (1 each)</p>  <p>M2.5 x 8 mm</p>	<p>Hard Drive: (2 each)</p>  <p>M3 x 3 mm</p>	<p>Modem: (1 each)</p>  <p>M2 x 3 mm</p>
<p>Internal Card With Bluetooth® Wireless Technology: (1 each)</p>  <p>M2.5 x 8 mm</p>	<p>Keyboard: (2 each)</p>  <p>M2.5 x 5 mm</p>	<p>Display Assembly: (4 each)</p>  <p>M2.5 x 5 mm</p>
<p>Display Bezel: (4 each, under rubber display bumpers)</p>  <p>M2.5 x 5 mm</p> <p>(4 each, shoulder type, under 2 screw covers and 2 rubber bumpers)</p>  <p>M2.5 x 5 mm</p>	<p>Display Panel: (8 each)</p>  <p>M2 x 3 mm</p> <p>Display Ground Screw: (1 each)</p>  <p>M2 x 3 mm</p>	<p>Palm Rest: (7 each – top side)</p>  <p>M2.5 x 5 mm</p> <p>(11 each – bottom side)</p>  <p>M2.5 x 8 mm</p>
<p>Speakers: (4 total – 2 per speaker)</p>  <p>M2.5 x 5 mm</p>	<p>USB Port Board: (1 each)</p>  <p>M2.5 x 5 mm</p>	<p>Fans (2): (4 total – 2 per fan)</p>  <p>M2.5 x 5 mm</p>

MCH Heat Sink:

(3 each)



M2.5 x 5 mm

PC Card Cage:

(4 each)



M2 x 3 mm

System Board:

(3 each)



M2.5 x 5 mm

Hard Drive Bay:

(4 each)



M2 x 3 mm

Stiffener Bracket:

(1 each)



M2.5 x 5 mm

[Back to Contents Page](#)

System Components

Dell™ Inspiron™ 9300 Service Manual

- ➔ **NOTICE:** Only a certified service technician should perform repairs on your computer. Damage due to servicing that is not authorized by Dell is not covered by your warranty.
- ➔ **NOTICE:** Unless otherwise noted, each procedure in this document assumes that a part can be replaced by performing the removal procedure in reverse order.

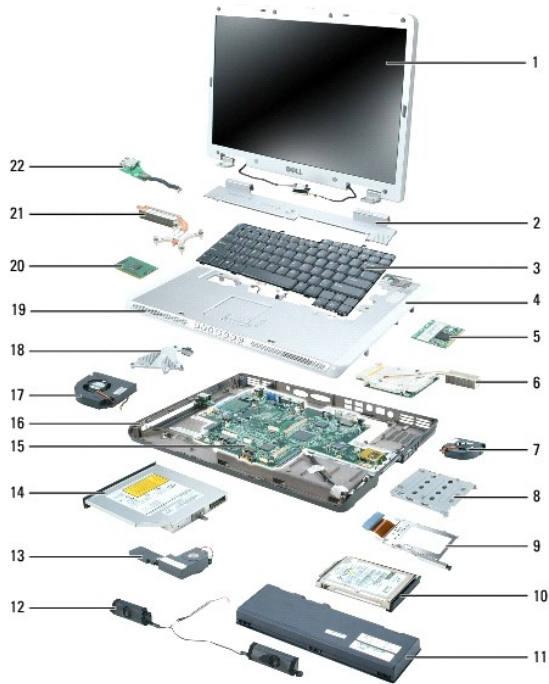

1	display assembly	12	speakers (2)
2	hinge cover	13	subwoofer
3	keyboard	14	optical drive
4	palm rest (with touch pad)	15	system board
5	Mini PCI card	16	computer base
6	video card/thermal cooling assembly	17	fan
7	fan	18	MCH heat sink
8	hard drive bay	19	speaker grille
9	PC Card cage	20	microprocessor
10	hard drive	21	microprocessor thermal-cooling assembly
11	main battery	22	USB port board

Optical Drive

Dell™ Inspiron™ 9300 Service Manual

Your computer ships with a fixed optical drive installed.

➡ **NOTICE:** To prevent damage to drives, store them in a safe, dry place when they are not installed in the computer. Avoid pressing down on them or placing heavy objects on top of them.

1. Follow the instructions in "[Before Working Inside Your Computer.](#)"
2. Turn the computer over and remove the M2.5 x 8-mm security screw labeled with a lock icon (🔒).
3. Insert a screwdriver into the indentation for the security screw, and push the notch on the metal tab to release the drive from the bay.

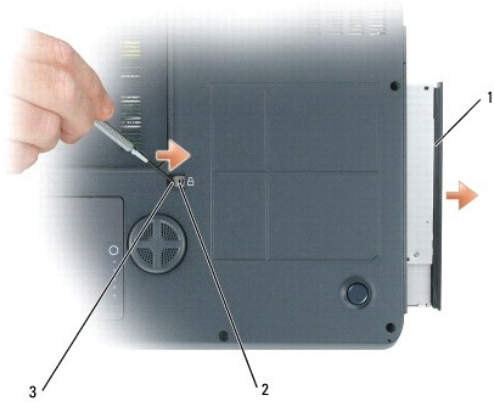

1	optical drive
2	indentation for M2.5 x 8-mm security screw
3	notch

4. Pull the drive out of the drive bay.

Hard Drive

Dell™ Inspiron™ 9300 Service Manual

- [Removing the Hard Drive](#)
 - [Replacing the Hard Drive](#)
 - [Returning a Hard Drive to Dell](#)
-

Removing the Hard Drive

- ⚠ **CAUTION:** If you remove the hard drive from the computer when the drive is hot, *do not touch* the metal housing of the hard drive.
- ⚠ **CAUTION:** Before you begin the following procedure, see the safety instructions in the *Product Information Guide*.
- 👉 **NOTICE:** To avoid damaging the system board, you must [remove the main battery](#) before you begin working inside the computer.
- 👉 **NOTICE:** To prevent data loss, turn off your computer before removing the hard drive. Do not remove the hard drive while the computer is on, in standby mode, or in hibernate mode.
- 👉 **NOTICE:** Hard drives are extremely fragile; even a slight bump can damage the drive.
- 📄 **NOTE:** Dell does not guarantee compatibility or provide support for hard drives from sources other than Dell.

1. Follow the instructions in "[Before Working Inside Your Computer](#)."
2. Turn the computer over and remove the two M3 x 3-mm screws.

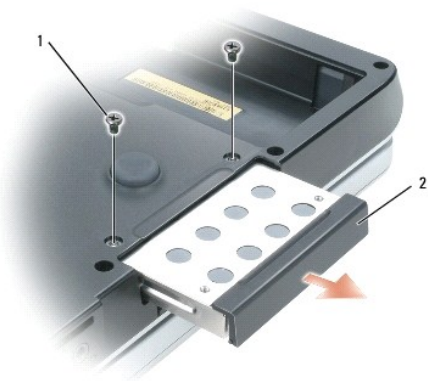

1	M3 x 3-mm screws (2)
2	hard drive

3. Slide the hard drive out of the computer.
- 👉 **NOTICE:** Use firm and even pressure to slide the drive into place. If you use excessive force, you may damage the connector.
-

Replacing the Hard Drive

1. Slide the drive into the bay until it is fully seated.
2. Replace and tighten the screws.
3. If you have installed a replacement (new) hard drive, reinstall the Microsoft® Windows® operating system.
4. Reinstall drivers on the new hard drive. For instructions, see "Reinstalling Drivers" in your *Owner's Manual*.

Returning a Hard Drive to Dell

Return your old hard drive to Dell in its original or comparable foam packaging. Otherwise, the hard drive may be damaged in transit.

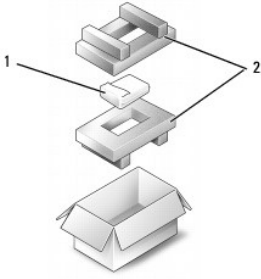

1	hard drive
2	foam packaging

[Back to Contents Page](#)

Memory Module

Dell™ Inspiron™ 9300 Service Manual

- [Removing the Memory Module](#)
- [Replacing the Memory Module](#)

Removing the Memory Module

- ⚠ **CAUTION:** Before you begin the following procedure, see the safety instructions in the *Product Information Guide*.
- 👉 **NOTICE:** To prevent static damage to components inside your computer, discharge static electricity from your body before you touch any of your computer's electronic components. You can do so by touching an unpainted metal surface.
- 👉 **NOTICE:** To avoid damaging the system board, you must [remove the main battery](#) before you begin working inside the computer.
- 📌 **NOTE:** Memory modules purchased from Dell are covered under your computer warranty.
- 📌 **NOTE:** To get maximum performance/dual-channel memory bandwidth capability, both memory module connectors must contain memory modules and the modules must be of the same size and configuration.

1. Follow the instructions in "[Before Working Inside Your Computer.](#)"
2. Turn the computer over, loosen the two captive screws from the memory module cover, and remove the cover.

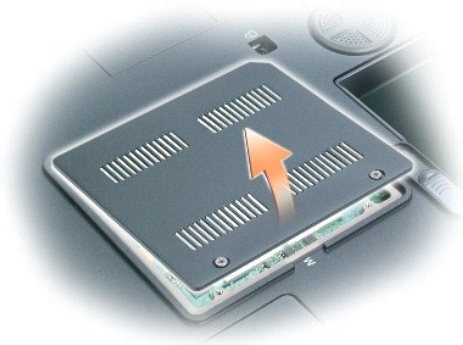

- 👉 **NOTICE:** To prevent damage to the memory module connector, do not use tools to spread the securing clips that secure the memory module.
- 👉 **NOTICE:** Handle memory modules by their edges, and do not touch the components on a module.
 - a. Use your fingertips to carefully spread apart the securing clips on each end of the memory module connector until the module pops up.
 - b. Remove the module from the connector at a 45-degree angle.

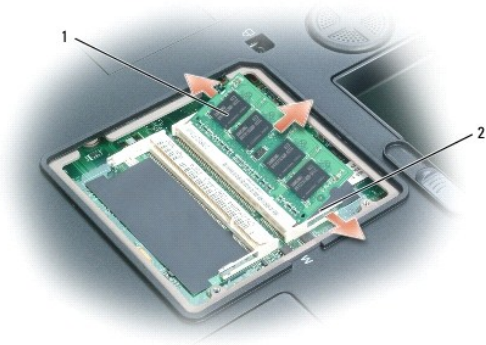

1	memory module
2	securing clip (2)

Replacing the Memory Module

- 🔧 **NOTE:** To get maximum performance/dual-channel memory bandwidth capability, both memory module connectors must contain memory modules and the modules must be of the same size and configuration.
- 🔧 **NOTE:** If a memory module is not installed properly, the computer will not boot.

1. Ground yourself and install the new memory module:
 - a. Align the notch in the module edge connector with the tab in the connector slot.
 - b. Slide the module firmly into the slot at a 45-degree angle, and rotate the module down until it clicks into place. If you do not feel the click, remove the module and reinstall it.

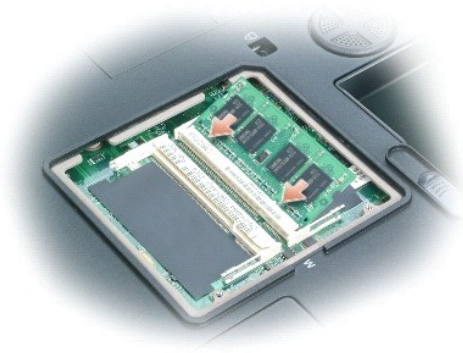

2. Replace the memory cover and tighten the captive screws.

- 🔧 **NOTICE:** If the memory module cover is difficult to close, remove the module and reinstall it. Forcing the cover to close may damage your computer.



3. Insert the battery into the battery bay, or connect the AC adapter to your computer and an electrical outlet.
4. Turn on the computer.

As the computer boots, it detects the additional memory and automatically updates the system configuration information.

Modem

Dell™ Inspiron™ 9300 Service Manual

- [Removing the Modem](#)
- [Replacing the Modem](#)

Removing the Modem

⚠ CAUTION: Before you begin the following procedure, see the safety instructions in the *Product Information Guide*.

👉 NOTICE: To avoid electrostatic discharge, ground yourself by using a wrist grounding strap or by periodically touching an unpainted metal surface (such as the back panel) on the computer.

👉 NOTICE: To avoid damaging the system board, you must [remove the main battery](#) before you begin working inside the computer.

👉 NOTICE:

1. Follow the instructions in "[Before Working Inside Your Computer](#)."
2. Turn the computer over, loosen the two captive screws on the modem cover, and remove the cover from the computer.



3. Remove the M2 x 3-mm screw that attaches the modem to the system board.
4. Pull up on the pull-tab to disconnect the modem from the connector on the system board.

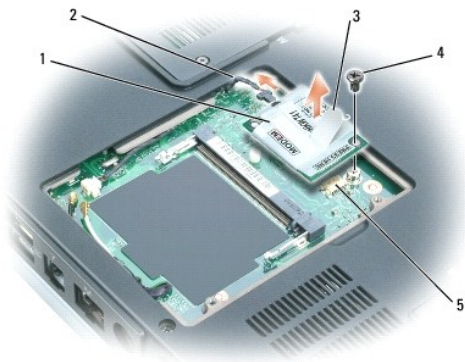

1	modem
2	modem cable
3	pull-tab
4	M2 x 3-mm screw

➡ **NOTICE:** Do not disconnect the modem cable from the system board.

5. Disconnect the modem cable from the modem.
-

Replacing the Modem

1. Connect the modem cable to the modem.

➡ **NOTICE:** Ensure that the modem cable is routed correctly when you replace the modem.

2. Connect the modem to the system board.

Align the connector on the bottom of the modem with the modem connector on the system board, and press down on the right side of the modem.

3. Replace the M2 x 3-mm screw.
-

[Back to Contents Page](#)

[Back to Contents Page](#)

Dell™ Inspiron™ 9300 Service Manual



NOTE: A NOTE indicates important information that helps you make better use of your computer.



NOTICE: A NOTICE indicates either potential damage to hardware or loss of data and tells you how to avoid the problem.



CAUTION: A CAUTION indicates a potential for property damage, personal injury, or death.

For a complete list of abbreviations and acronyms, see the *Dell Inspiron Help* file. To access the help file, click the **Start** button, click **Help and Support**, click **User and system guides**, click **User's guides**, and click **Dell Inspiron Help**.

If you purchased a Dell™ n Series computer, any references in this document to Microsoft® Windows® operating systems are not applicable.

Information in this document is subject to change without notice.
© 2005 Dell Inc. All rights reserved.

Reproduction in any manner whatsoever without the written permission of Dell Inc. is strictly forbidden.

Trademarks used in this text: *Dell*, the *DELL* logo, and *Inspiron* are trademarks of Dell Inc.; *Microsoft* and *Windows* are registered trademarks of Microsoft Corporation; *Bluetooth* is a registered trademark owned by Bluetooth SIG, Inc. and is used by Dell Inc. under license.

Other trademarks and trade names may be used in this document to refer to either the entities claiming the marks and names or their products. Dell Inc. disclaims any proprietary interest in trademarks and trade names other than its own.

Model PP14L

February 2005 Rev. A00

[Back to Contents Page](#)

Mini PCI Card

Dell™ Inspiron™ 9300 Service Manual

- [Removing the Mini PCI Card](#)
- [Replacing the Mini PCI Card](#)

Removing the Mini PCI Card

⚠ CAUTION: If you are removing and/or installing a 2.4-GHz (802.11b, 802.11b/g) Mini PCI card, follow the instructions noted below. Only products approved for use in your portable computer may be installed. Approved Mini PCI cards may be purchased only from Dell.

⚠ CAUTION: Before you begin the following procedure, see the safety instructions in the *Product Information Guide*.

🔁 NOTICE: To avoid damaging the system board, you must [remove the main battery](#) before you begin working inside the computer.

🔧 NOTE: 2.4-GHz Wireless LAN PC Cards may be removed and installed by the user.

1. Follow the instructions in "[Before Working Inside Your Computer](#)."

🔧 NOTE: If you ordered a Mini PCI card with your computer, the card is already installed. If a Mini PCI card is not already installed, see "[Replacing the Mini PCI Card](#)." If you are replacing a Mini PCI card, remove the existing card.

2. Turn the computer over and loosen the two captive screws on the Mini PCI card cover.
3. Place your finger under the cover at the indentation and lift the cover open.



4. Disconnect the antenna cables from the Mini PCI card.



1 antenna cables (2)

🔁 NOTICE: To prevent damage to the Mini PCI card connector, do not use tools to spread the securing clips that secure the card.

5. Release the Mini PCI card by spreading the metal securing tabs until the card pops up slightly.
6. Remove the Mini PCI card from the connector at a 45-degree angle.



1	Mini PCI card
2	metal securing tabs (2)

Replacing the Mini PCI Card

- ➔ **NOTICE:** To avoid damaging the antenna cables or the Mini PCI card, never place the cables under the card.
- ➔ **NOTICE:** The connectors are keyed to ensure correct insertion. If you feel resistance, check the connectors and realign the card.

1. Align the Mini PCI card with the connector at a 45-degree angle, and press the Mini PCI card into the connector until it clicks.



2. Connect the antenna cables to the Mini PCI card.



1 antenna cables (2)

3. Replace the cover.

[Back to Contents Page](#)

Internal Card With Bluetooth® Wireless Technology

Dell™ Inspiron™ 9300 Service Manual

- [Removing the Card](#)
- [Replacing the Card](#)

Removing the Card

- ⚠ **CAUTION:** Before you begin the following procedure, see the safety instructions in the *Product Information Guide*.
- 👉 **NOTICE:** To avoid electrostatic discharge, ground yourself by using a wrist grounding strap or by periodically touching an unpainted metal surface (such as the back panel) on the computer.
- 👉 **NOTICE:** To avoid damaging the system board, you must [remove the main battery](#) before you begin working inside the computer.
- 📌 **NOTE:** If you ordered an internal card with Bluetooth wireless technology with your computer, the card is already installed.

1. Follow the instructions in "[Before Working Inside Your Computer](#)."
2. Remove the M2.5 x 8-mm screw and remove the card cover from the computer.
3. Pull the card out of the compartment so that you can disconnect the card from its cable and remove it from the computer.

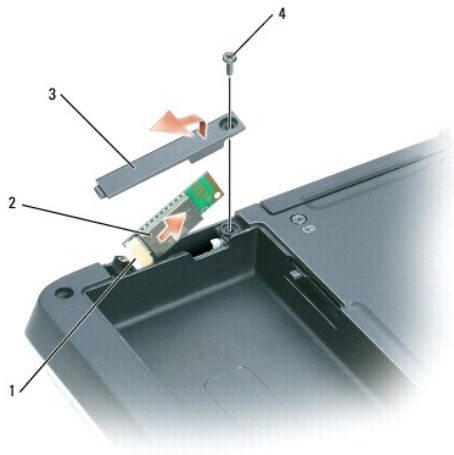

1	card connector
2	internal card with Bluetooth wireless technology
3	card door
3	M2.5 x 8-mm screw

Replacing the Card

1. Connect the card to the cable and then carefully insert the card into the compartment.
2. Replace the card cover and the screw.
3. Replace the battery.

Hinge Cover

Dell™ Inspiron™ 9300 Service Manual

- [Removing the Hinge Cover](#)
- [Replacing the Hinge Cover](#)

Removing the Hinge Cover

- ⚠ **CAUTION:** Before you begin the following procedure, see the safety instructions in the *Product Information Guide*.
- ➡ **NOTICE:** To avoid electrostatic discharge, ground yourself by using a wrist grounding strap or by periodically touching an unpainted metal surface (such as the back panel) on the computer.
- ➡ **NOTICE:** To avoid damaging the system board, you must [remove the main battery](#) before you begin working inside the computer.
- ➡ **NOTICE:** The hinge cover is fragile and can be damaged if extreme force is used. Be careful when removing the hinge cover.

1. Follow the instructions in "[Before Working Inside Your Computer](#)."
2. Open the display all the way (180 degrees) so that it lies flat against your work surface.
3. Using a small flat-blade screwdriver, insert the screwdriver on the right side to gently pry the hinge cover loose.
4. Pulling up from right to left, remove the hinge cover.



1 hinge cover

5. Disconnect your computer and all attached devices from their electrical outlets.

Replacing the Hinge Cover

With the display open all the way (180 degrees) so that it lies flat against the work surface, snap the cover back into place, starting from left to right.

Keyboard

Dell™ Inspiron™ 9300 Service Manual

- [Removing the Keyboard](#)
- [Replacing the Keyboard](#)

Removing the Keyboard

⚠ CAUTION: Before you begin the following procedure, see the safety instructions in the *Product Information Guide*.

👉 NOTICE: To avoid electrostatic discharge, ground yourself by using a wrist grounding strap or by periodically touching an unpainted metal surface (such as the back panel) on the computer.

👉 NOTICE: To avoid damaging the system board, you must [remove the main battery](#) before you begin working inside the computer.

1. Follow the instructions in "[Before Working Inside Your Computer](#)."
2. Open the display all the way (180 degrees) so that it lies flat against your work surface.
3. Remove the [hinge cover](#).
4. Remove the two M2.5 x 5-mm screws across the top of the keyboard.

👉 NOTICE: The key caps on the keyboard are fragile, easily dislodged, and time-consuming to replace. Be careful when removing and handling the keyboard.

5. Tilt up the rear corners of the keyboard and gently slide it toward the display.
6. Hold the keyboard up and slightly forward to allow access to the keyboard connector.
7. Pull up on the keyboard connector pull-tab to disconnect the keyboard connector from the system board.
8. Remove the keyboard.



1	keyboard
2	M2.5 x 5-mm screws (2)
3	keyboard connector pull-tab
4	system board connector
5	tabs (5)

Replacing the Keyboard

 **NOTICE:** To avoid scratching the palm rest when replacing the keyboard, hook the five tabs along the front edge of the keyboard into the palm rest, and then secure the keyboard into place. Also, be sure the display panel is lying flat (180 degrees) against the working surface to avoid scratching the display panel.

1. Reconnect the keyboard to the system board connector.
2. Slide the bottom of the keyboard into the computer base.

 **NOTE:** You may need to push the bottom of the keyboard down slightly to seat the keyboard into the computer base.

3. Replace the two M2.5 x 5-mm screws across the top of the keyboard.
4. Replace the [hinge cover](#).

[Back to Contents Page](#)

Display

Dell™ Inspiron™ 9300 Service Manual

- [Display Assembly](#)
 - [Display Bezel](#)
 - [Display Panel](#)
 - [Display Latch](#)
-

Display Assembly

Removing the Display Assembly

- ⚠ **CAUTION:** Before you begin the following procedure, see the safety instructions in the *Product Information Guide*.
- 🔧 **NOTICE:** To avoid electrostatic discharge, ground yourself by using a wrist grounding strap or by periodically touching an unpainted metal surface (such as the back panel) on the computer.
- 🔧 **NOTICE:** To avoid damaging the system board, you must [remove the main battery](#) before you begin working inside the computer.

1. Follow the instructions in "[Before Working Inside Your Computer](#)."
2. Turn the computer over and loosen the two captive screws on the Mini PCI card cover.



- 🔧 **NOTE:** If a Mini PCI card is installed, you will need to disconnect the antenna cables from the card. If one is not installed, detach the antenna cables from their secured location.

3. Disconnect the antenna cables from the Mini PCI card, if applicable.



1 antenna cables

4. Turn the computer top-side up.
5. Remove the [hinge cover](#).
6. Open the display all the way (180 degrees) so that it lies flat against the work surface.
7. Use the pull-tab to disconnect the display cable, and then disengage the display cable from the cable channel.
8. Remove the four M2.5 x 5-mm screws (two on each side) that connect the display to the computer base.

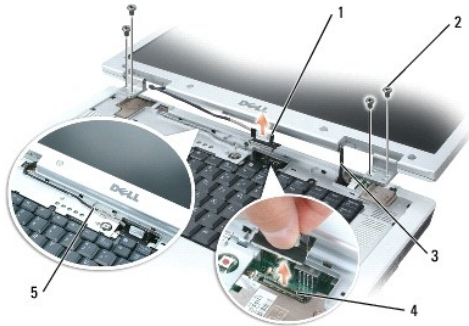

1	display cable pull-tab
2	M2.5 x 5-mm screws (4)
3	Mini PCI card antenna cables (2)
4	display cable connector on system board
5	display cable in cable channel



1 Mini PCI card antenna cables

 **NOTE:** When removing the display assembly, carefully unthread the Mini PCI card antenna cables through the computer base.

9. Lift the display assembly away from the computer.

Replacing the Display Assembly

1. Align the display assembly over the screw holes in the base of the computer.
2. Replace the four M2.5 x 5-mm screws.

3. Thread the Mini PCI card antenna cables back through the hole in the base of the computer so that they are accessible from the bottom of the computer.

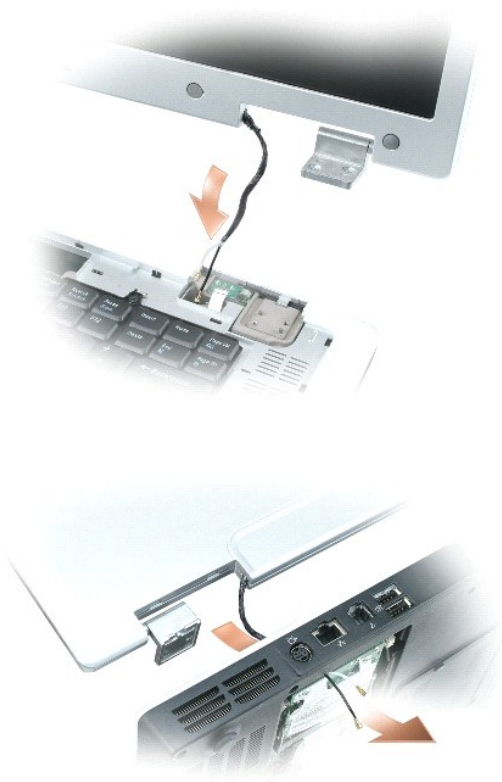

4. Connect the display cable to the system board.
5. Reroute the display cable into the cable channel.
6. Replace the [hinge cover](#).
7. If a Mini PCI card is installed, [connect the antenna cables to the card](#). If one is not installed, tuck the antenna cables into their secured location.
8. Replace the Mini PCI card cover.

Display Bezel

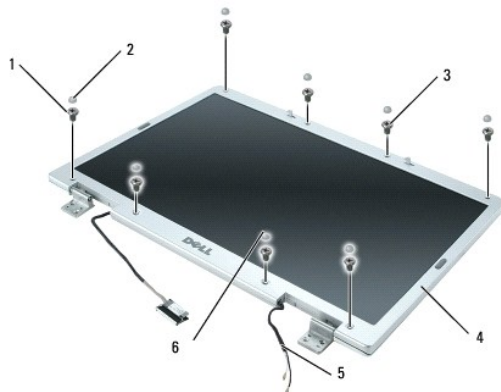

1	M2.5 x 5-mm screws (4)	4	display bezel
2	rubber screw-covers/display bumpers (6)	5	antenna cables

3	shoulder screws (4)	6	screw covers (2)
---	---------------------	---	------------------

Removing the Display Bezel

⚠ CAUTION: Before you begin the following procedure, see the safety instructions in the *Product Information Guide*.

➡ NOTICE: To avoid electrostatic discharge, ground yourself by using a wrist grounding strap or by periodically touching an unpainted metal surface (such as the back panel) on the computer.

➡ NOTICE: To avoid damaging the system board, you must [remove the main battery](#) before you begin working inside the computer.

1. Follow the instructions in "[Before Working Inside Your Computer](#)."

2. Remove the [display assembly](#).

3. Remove the six rubber screw-covers/display bumpers.

4. Remove the two screw covers and the four shoulder screws.

5. Remove the four M2.5 x 5-mm screws at the corners of the bezel.

➡ NOTICE: Removal of the bezel from the display back cover requires extreme care to avoid damage to the bezel.

6. Use your fingers to separate the bezel from the display back cover by pulling the lower-right corner of the bezel down toward the bottom edge (A) of the display assembly to clear the tab on the bottom of the lower-right corner. Then pull the bezel toward the right side of the display assembly to clear the tab on the side (B) of the lower-right corner.

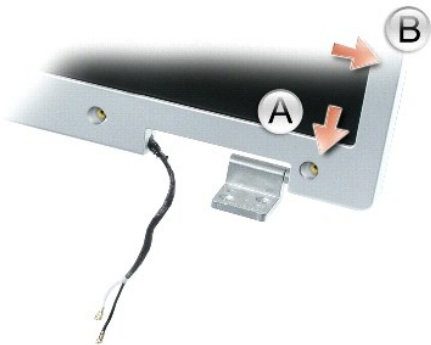

1	display back cover
2	tabs

7. Repeat [step 6](#) for the lower-left corner of the bezel. Then use your fingers to release the snaps around the rest of the bezel and lift it away from the display panel.



1	display bezel
2	display panel

Replacing the Display Bezel

1. Starting at any corner, use your fingers to gently snap the bezel into place to secure it to the display panel.
 2. Replace the four M2.5 x 5-mm screws on the corners of the bezel.
 3. Replace the four shoulder screws and two screw covers.
 4. Replace the six rubber screw-cover/display bumpers around the bezel.
-

Display Panel

Removing the Display Panel

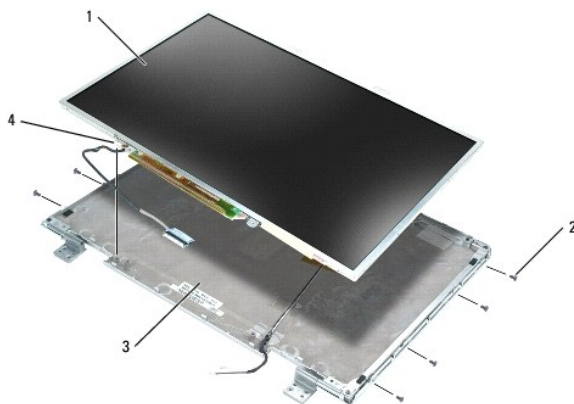

1	display panel
2	M2 x 3-mm screws (8)
3	display back cover
4	grounding wire and screw

⚠ CAUTION: Before you begin the following procedure, see the safety instructions in the *Product Information Guide*.

👉 NOTICE: To avoid electrostatic discharge, ground yourself by using a wrist grounding strap or by touching an unpainted metal surface on the computer.

👉 NOTICE: To avoid damaging the system board, you must [remove the main battery](#) before you begin working inside the computer.

1. Follow the instructions in "[Before Working Inside Your Computer](#)."
2. Remove the [display assembly](#).
3. Remove the [display bezel](#).
4. Remove the M2 x 3-mm ground screw that attaches the display-panel ground wire to the display back cover.
5. Remove the eight M2 x 3-mm screws (four on each side of the display panel).
6. Lift the display panel out of the display back cover.
7. Press in both sides of the top flex-cable connector, and pull the top flex-cable connector away from the display connector.
8. Use the pull-tab to disconnect the bottom flex-cable connector from the inverter connector.

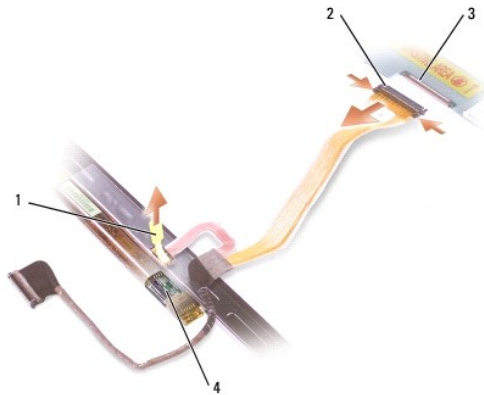

1	pull-tab on bottom flex-cable connector
2	top flex-cable connector
3	display cable connector
4	inverter connector

Replacing the Display Panel

1. Reconnect the top display cable connector to the top flex-cable connector.
2. Reconnect the bottom flex-cable connector to the inverter connector.
3. Replace the display panel inside the display back cover.
4. Replace the M2 x 3-mm ground screw that attaches the display-panel ground wire to the back display back cover.
5. Replace the eight M2 x 3-mm screws (four on each side) around the display panel.
6. Replace the [display bezel](#).

Display Latch

Removing the Display Latch

⚠ CAUTION: Before you begin the following procedure, see the safety instructions in the *Product Information Guide*.

➡ NOTICE: To avoid electrostatic discharge, ground yourself by using a wrist grounding strap or by touching an unpainted metal surface on the computer.

➡ NOTICE: To avoid damaging the system board, you must [remove the main battery](#) before you begin working inside the computer.

1. Follow the instructions in "[Before Working Inside Your Computer](#)."
2. Remove the [display](#).
3. Remove the [display bezel](#).
4. Slide the latch to the right and gently lift.
5. Remove the spring that attaches the latch to the display panel.

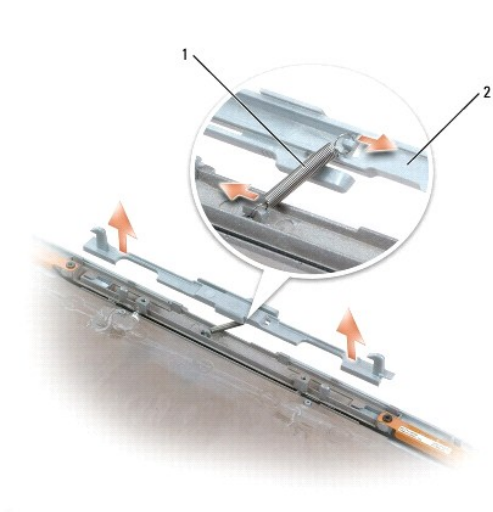

1	spring
2	display latch

Replacing the Display Latch

1. Replace the spring that attaches the latch to the display panel.
2. Align the latch with the display panel and slide the latch to the left to secure it into place.

[Back to Contents Page](#)

Palm Rest

Dell™ Inspiron™ 9300 Service Manual

- [Removing the Palm Rest](#)
- [Replacing the Palm Rest](#)

Removing the Palm Rest

⚠ CAUTION: Before you begin the following procedure, see the safety instructions in the *Product Information Guide*.

⚡ NOTICE: To avoid electrostatic discharge, ground yourself by using a wrist grounding strap or by periodically touching an unpainted metal surface (such as the back panel) on the computer.

⚡ NOTICE: To avoid damaging the system board, you must [remove the main battery](#) before you begin working inside the computer.

1. Follow the instructions in "[Before Working Inside Your Computer](#)."
2. Remove the [optical drive](#).
3. Remove the [hinge cover](#).
4. Remove the [keyboard](#).
5. Remove the [display assembly](#).
6. Remove the seven M2.5 x 5-mm screws labeled "P" from the top side of the palm rest.

🔍 NOTE: The screw locations may vary slightly from the image shown below.

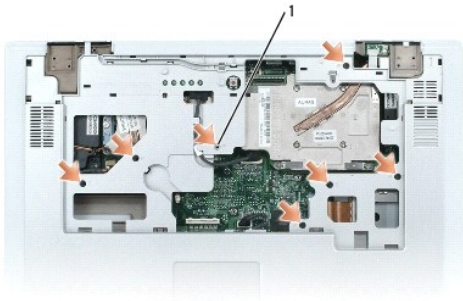

1	M2.5 x 5-mm screws (7)
---	------------------------

🔍 NOTE: If you are installing a new palm rest, remove the coin-cell battery from the old palm rest so that you can install it on the new palm rest. If you are removing the palm rest only to access other computer components, you do not need to remove the coin-cell battery from the palm rest.

7. Remove the [coin-cell battery](#), if appropriate.
8. Turn the computer over and remove the 11 M2.5 x 8-mm screws from the bottom of the computer.

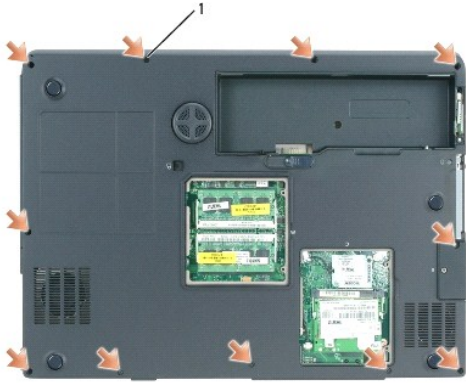

1 M2.5 x 8-mm screws (11)

9. Turn the computer top-side up and disconnect the touch-pad connector from the system board.

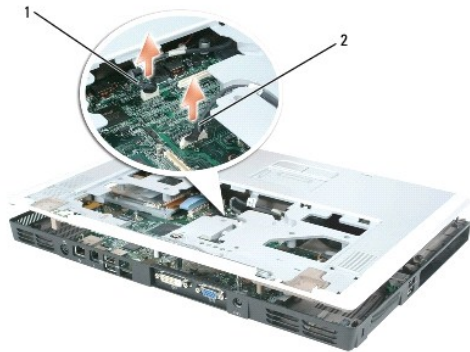

1 touch-pad connector
2 LED board connector

10. Disconnect the LED board connector.
11. Lift the palm rest and remove it from the computer.

Replacing the Palm Rest

1. Align the palm rest with the bottom plastics and gently snap it into place.
 2. Reconnect the touch-pad connector to the system board.
 3. Reconnect the LED board to the system board.
 4. Replace the [coin-cell battery](#).
 5. Replace the seven M2.5 x 5-mm screws on the top side of the palm rest.
 6. Turn the computer over, and replace the 11 M2.5 x 8-mm screws on the bottom of the computer.
 7. Replace the [display assembly](#).
 8. Replace the [keyboard](#).
 9. Replace the [hinge cover](#).
-

[Back to Contents Page](#)

Coin-Cell Battery

Dell™ Inspiron™ 9300 Service Manual

- [Removing the Coin-Cell Battery](#)
- [Replacing the Coin-Cell battery](#)

Removing the Coin-Cell Battery

⚠ CAUTION: Before you begin the following procedure, see the safety instructions in the *Product Information Guide*.

👉 NOTICE: To avoid electrostatic discharge, ground yourself by using a wrist grounding strap or by periodically touching an unpainted metal surface (such as the back panel) on the computer.

👉 NOTICE: To avoid damaging the system board, you must [remove the main battery](#) before you begin working inside the computer.

1. Follow the instructions in "[Before Working Inside Your Computer](#)."
2. Remove the [hinge cover](#).
3. Remove the [keyboard](#).
4. Remove the existing coin-cell battery:
 - a. Disconnect the battery cable connector from the system board.
 - b. Press the release latch on the side of the coin-cell battery compartment, and lift up the battery.

🔧 NOTE: You may experience slight resistance when you lift the battery because of an adhesive underneath the battery that holds it in place.

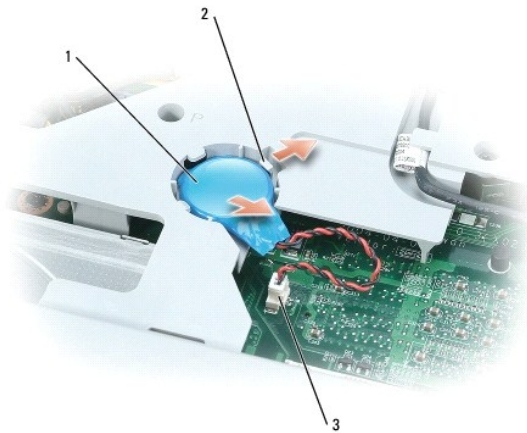

1	coin-cell battery
2	release latch
3	battery cable connector

Replacing the Coin-Cell battery

1. Install the replacement battery:
 - a. With the positive side up, insert the battery at a 30-degree angle under the release latch, and then push the battery into place.
 - b. Connect the battery cable to the connector on the system board.
2. Replace the [keyboard](#).
3. Replace the [hinge cover](#).



[Back to Contents Page](#)

Speakers

Dell™ Inspiron™ 9300 Service Manual

- [Removing the Speakers](#)
- [Replacing the Speakers](#)

Removing the Speakers

⚠ CAUTION: Before you begin the following procedure, see the safety instructions in the *Product Information Guide*.

➡ NOTICE: To avoid electrostatic discharge, ground yourself by using a wrist grounding strap or by periodically touching an unpainted metal surface (such as the back panel) on the computer.

➡ NOTICE: To avoid damaging the system board, you must [remove the main battery](#) before you begin working inside the computer.

1. Follow the instructions in "[Before Working Inside Your Computer](#)."
2. Remove the [hinge cover](#).
3. Remove the [keyboard](#).
4. Remove the [display assembly](#).
5. Remove the [palm rest](#).

➡ NOTICE: Handle the speakers with care to avoid damaging them.

6. Disconnect the speaker connector from the system board.
7. Lift the tape securing the speaker cables to the computer base, and disengage the cables from the cable guides.
8. Remove the four M2.5 x 5-mm screws from the speakers (two on each speaker).
9. Remove the speakers.

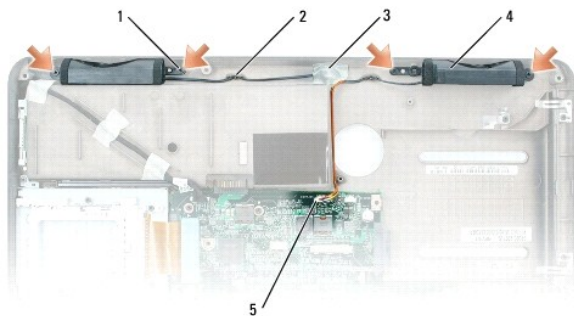

1	M2.5 x 5-mm screws (4)
2	cable guides
3	tape
4	speakers (2)
5	speaker connector on the system board

Replacing the Speakers

1. Connect the speaker connector to the system board connector.

2. Align the speakers on the screw holes for securing the speakers to the computer base.
 3. Replace the four M2.5 x 5-mm screws to secure the speakers in place (two on each speaker).
 4. Re-route the speaker cables into the cable guides, and re-adhere the tape to secure the speaker cables in place on the computer base.
-

[Back to Contents Page](#)

Subwoofer

Dell™ Inspiron™ 9300 Service Manual

- [Removing the Subwoofer](#)
- [Replacing the Subwoofer](#)

Removing the Subwoofer

⚠ CAUTION: Before you begin the following procedure, see the safety instructions in the *Product Information Guide*.

- **ⓘ NOTICE:** To avoid electrostatic discharge, ground yourself by using a wrist grounding strap or by periodically touching an unpainted metal surface (such as the back panel) on the computer.
- **ⓘ NOTICE:** To avoid damaging the system board, you must [remove the main battery](#) before you begin working inside the computer.

If you ordered a subwoofer with your computer, it is already installed. To remove and replace a subwoofer:

1. Follow the instructions in "[Before Working Inside Your Computer](#)."
2. Remove the [optical drive](#).
3. Remove the hinge cover.
4. Remove the keyboard.
5. Remove the [display assembly](#).
6. Remove the [palm rest](#).
7. Loosen the two captive screws that secure the subwoofer in place.



1	subwoofer
2	subwoofer cable connector
3	system board connector

8. Disconnect the subwoofer cable connector from the system board.

Replacing the Subwoofer

1. Reconnect the subwoofer cable to the system board.

2. Place the subwoofer onto the system board.
3. Tighten the two captive screws that secure the subwoofer in place.

[Back to Contents Page](#)

USB Port Board

Dell™ Inspiron™ 9300 Service Manual

- [Removing the USB Port Board](#)
- [Replacing the USB Port Board](#)

Removing the USB Port Board

⚠ CAUTION: Before you begin the following procedure, see the safety instructions in the *Product Information Guide*.

🔌 NOTICE: To avoid electrostatic discharge, ground yourself by using a wrist grounding strap or by periodically touching an unpainted metal surface (such as the back panel) on the computer.

🔌 NOTICE: To avoid damaging the system board, you must [remove the main battery](#) before you begin working inside the computer.

1. Follow the instructions in "[Before Working Inside Your Computer](#)."
2. Remove the [hinge cover](#).
3. Remove the [keyboard](#).
4. Remove the [display assembly](#).
5. Remove the [palm rest](#).
6. Disconnect the USB-port-board cable connector from the system board.
7. Remove the M2.5 x 5-mm screw, and lift the board up and out of the computer.

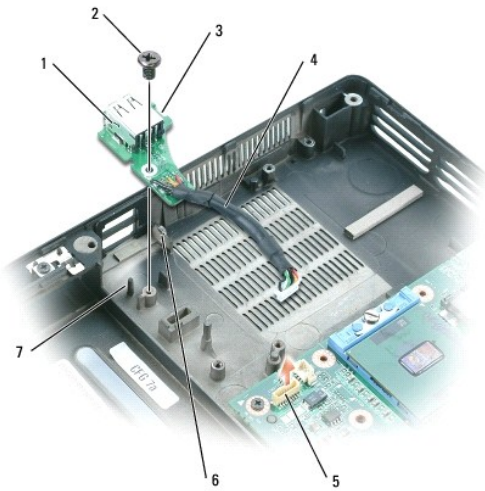

1	USB port board
2	M2.5 x 5-mm screw
3	notch
4	USB-port-board cable
5	system board connector
6	tab
7	pin

Replacing the USB Port Board

1. Insert the notch on the USB port board under the small tab on the computer base and the other side of the board over the pin.
2. Replace the M2.5 x 5-mm screw.
3. Reconnect the cable to the system board.
4. Perform the steps in "[Removing the USB Port Board](#)" in reverse order.
5. Replace the [palm rest](#).
6. Replace the [display assembly](#).
7. Replace the [keyboard](#).
8. Replace the [hinge cover](#).

[Back to Contents Page](#)

Microprocessor Thermal-Cooling Assembly

Dell™ Inspiron™ 9300 Service Manual

- [Removing the Microprocessor Thermal-Cooling Assembly](#)
- [Replacing the Microprocessor Thermal-Cooling Assembly](#)

Removing the Microprocessor Thermal-Cooling Assembly

⚠ CAUTION: Before you begin the following procedure, see the safety instructions in the *Product Information Guide*.

👉 NOTICE: To avoid electrostatic discharge, ground yourself by using a wrist grounding strap or by periodically touching an unpainted metal surface (such as the back panel) on the computer.

👉 NOTICE: To avoid damaging the system board, you must [remove the main battery](#) before you begin working inside the computer.

1. Follow the instructions in "[Before Working Inside Your Computer](#)."
2. Remove the [hinge cover](#).
3. Remove the [keyboard](#).
4. Remove the [display assembly](#).
5. Remove the [palm rest](#).
6. Loosen in consecutive order the four captive screws, labeled "1" through "4," that secure the microprocessor thermal-cooling assembly to the system board.
7. Lift up the microprocessor thermal-cooling assembly and remove it from the system board.



1	microprocessor thermal-cooling assembly
2	captive screws (4)

Replacing the Microprocessor Thermal-Cooling Assembly

1. Evenly apply thermal grease to the top surface of the microprocessor.
2. Place the microprocessor thermal-cooling assembly over the microprocessor.
3. Tighten the four captive screws, labeled "1" through "4," in consecutive order.

[Back to Contents Page](#)

Microprocessor Module

Dell™ Inspiron™ 9300 Service Manual

- [Removing the Microprocessor Module](#)
- [Replacing the Microprocessor Module](#)

Removing the Microprocessor Module

⚠ CAUTION: Before you begin the following procedure, see the safety instructions in the *Product Information Guide*.

- ➡ **NOTICE:** To avoid electrostatic discharge, ground yourself by using a wrist grounding strap or by periodically touching an unpainted metal surface (such as the back panel) on the computer.
- ➡ **NOTICE:** Do not touch the processor die. Press and hold the microprocessor down on the substrate on which the die is mounted while turning the cam screw to prevent intermittent contact between the cam screw and microprocessor.
- ➡ **NOTICE:** To avoid damage to the microprocessor, hold the screwdriver so that it is perpendicular to the microprocessor when turning the cam screw.
- ➡ **NOTICE:** To avoid damaging the system board, you must [remove the main battery](#) before you begin working inside the computer.

1. Follow the instructions in "[Before Working Inside Your Computer](#)."
2. Remove the [hinge cover](#).
3. Remove the [keyboard](#).
4. Remove the [display assembly](#).
5. Remove the [palm rest](#).

➡ **NOTICE:** To ensure maximum cooling for the microprocessor, do not touch the heat transfer areas on the microprocessor thermal-cooling assembly. The oils in your skin reduce the heat transfer capability of the thermal pads.

6. Remove the [microprocessor thermal-cooling assembly](#).

➡ **NOTICE:** When removing the microprocessor module, pull the module straight up. Be careful not to bend the pins on the microprocessor module.

7. To loosen the ZIF socket, use a small, flat-blade screwdriver and rotate the ZIF-socket cam screw counterclockwise until it comes to the cam stop.

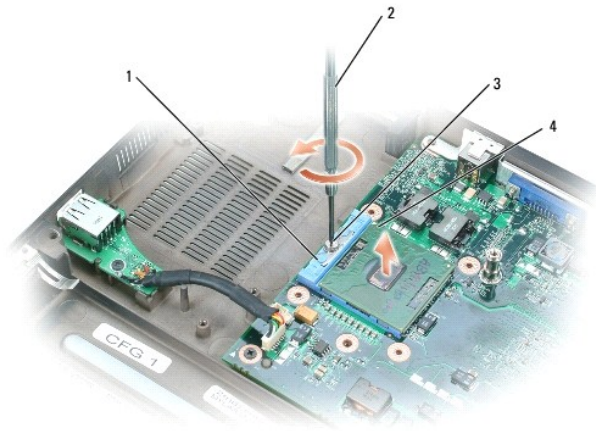



1	ZIF socket
2	screwdriver (perpendicular to microprocessor)
3	ZIF-socket cam screw
4	pin-1 corner

 **NOTE:** The ZIF-socket cam screw secures the microprocessor to the system board. Take note of the arrow on the ZIF-socket cam screw, which indicates the direction to turn the cam screw.

8. Lift the microprocessor module from the ZIF socket.
-

Replacing the Microprocessor Module

 **NOTICE:** Ensure that the cam lock is in the fully open position before seating the microprocessor module. Seating the microprocessor module properly in the ZIF socket does not require force.

 **NOTICE:** A microprocessor module that is not properly seated can result in an intermittent connection or permanent damage to the microprocessor and ZIF socket.

1. Align the pin-1 corner of the microprocessor module with the pin-1 corner of the ZIF socket, and insert the microprocessor module.

 **NOTE:** The pin-1 corner of the microprocessor module has a triangle that aligns with the triangle on the pin-1 corner of the ZIF socket.

 **NOTICE:** You must position the microprocessor module correctly in the ZIF socket to avoid permanent damage to the module and the socket.

When the microprocessor module is correctly seated, all four corners are aligned at the same height. If one or more corners of the module are higher than the others, the module is not seated correctly.

2. Tighten the ZIF socket by turning the cam screw clockwise to secure the microprocessor module to the system board.
 3. Perform the steps in "Removing the Microprocessor Module" in reverse order, beginning with [step 6](#).
-

[Back to Contents Page](#)

Video Card/Thermal Cooling Assembly

Dell™ Inspiron™ 9300 Service Manual

- [Removing the Video Card/Thermal Cooling Assembly](#)
- [Replacing the Video Card/Thermal Cooling Assembly](#)

Removing the Video Card/Thermal Cooling Assembly

- ⚠ **CAUTION:** Before you begin the following procedure, see the safety instructions in the *Product Information Guide*.
- 🔌 **NOTICE:** To avoid electrostatic discharge, ground yourself by using a wrist grounding strap or by periodically touching an unpainted metal surface (such as the back panel) on the computer.
- 🔌 **NOTICE:** To avoid damaging the system board, you must [remove the main battery](#) before you begin working inside the computer.
- 📌 **NOTE:** If you ordered a video card with your computer, it is already installed.

1. Follow the instructions in "[Before Working Inside Your Computer](#)."
2. Remove the [hinge cover](#).
3. Remove the [keyboard](#).
4. Remove the [display assembly](#).
5. Remove the [palm rest](#).

- 📌 **NOTE:** Remove the video card/thermal cooling assembly as a single unit. Do not separate the thermal cooling assembly from the video card.

6. Loosen the four captive screws on the video card/thermal cooling assembly.
7. Lift the video card/thermal cooling assembly from the system board.

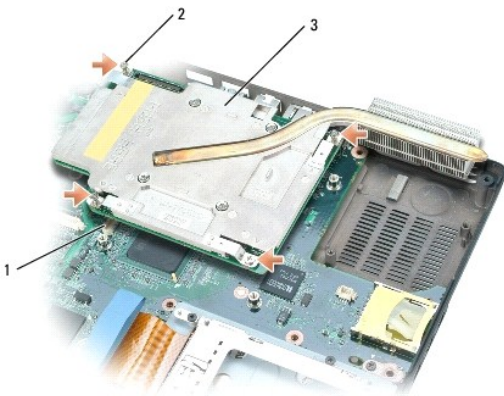

1	system board connector
2	captive screws (4)
3	video card/thermal cooling assembly

Replacing the Video Card/Thermal Cooling Assembly

1. Carefully align the video card/thermal cooling assembly over the connector on the system board and press down.

- 📌 **NOTE:** The video card/thermal cooling assembly is labeled "PUSH HERE."



2. Tighten the four captive screws on the video card/thermal cooling assembly.

[Back to Contents Page](#)

System Fans

Dell™ Inspiron™ 9300 Service Manual

- [Removing the System Fans](#)
- [Replacing the System Fans](#)

Removing the System Fans

⚠ CAUTION: Before you begin the following procedure, see the safety instructions in the *Product Information Guide*.

🔌 NOTICE: To avoid electrostatic discharge, ground yourself by using a wrist grounding strap or by periodically touching an unpainted metal surface (such as the back panel) on the computer.

🔌 NOTICE: To avoid damaging the system board, you must [remove the main battery](#) before you begin working inside the computer.

1. Follow the instructions in "[Before Working Inside Your Computer](#)."
2. Remove the [hinge cover](#).
3. Remove the [keyboard](#).
4. Remove the [display assembly](#).
5. Remove the [palm rest](#).

🔍 NOTE: This computer has two system fans. One is for the processor (the larger one on the left side) and the other is for the graphics card (the smaller one on the right side).

6. Remove the two M2.5 x 5-mm screws from each of the fans, and then remove the connector that connects each fan to the system board.
7. Lift each fan out of the computer.

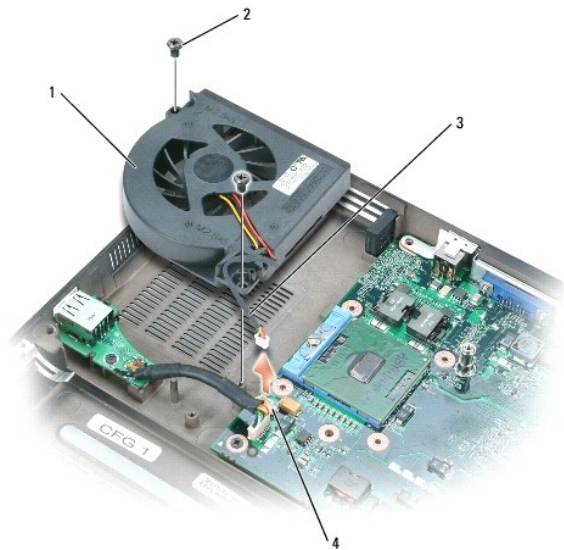

1	fan
2	M2.5 x 5-mm screws (2)
3	fan cable
4	fan-cable system board connector

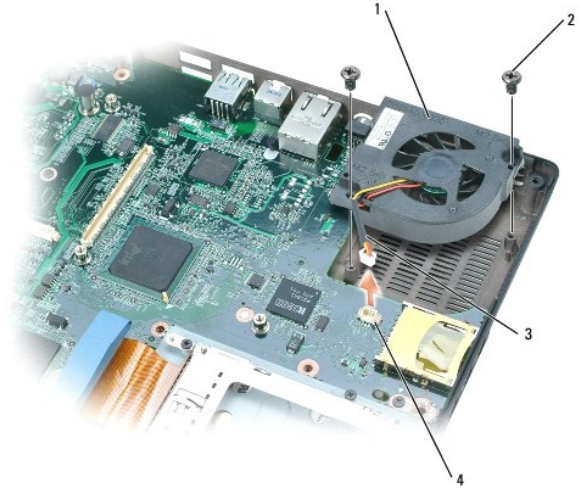

1	fan
2	M2.5 x 5-mm screws (2)
3	fan cable
4	fan-cable system board connector

Replacing the System Fans

1. Align and place each fan over its respective screw holes on the system board.
2. Replace the four M2.5 x 5-mm screws (two on each fan).
3. Connect the cable for each fan to the system board.

[Back to Contents Page](#)

MCH Heat Sink

Dell™ Inspiron™ 9300 Service Manual

- [Removing the MCH Heat Sink](#)
- [Replacing the MCH Heat Sink](#)

Removing the MCH Heat Sink

⚠ CAUTION: Before you begin the following procedure, see the safety instructions in the *Product Information Guide*.

- **⚠ NOTICE:** To avoid electrostatic discharge, ground yourself by using a wrist grounding strap or by periodically touching an unpainted metal surface (such as the back panel) on the computer.
- **⚠ NOTICE:** To avoid damaging the system board, you must [remove the main battery](#) before you begin working inside the computer.

1. Follow the instructions in "[Before Working Inside Your Computer](#)."
2. Remove the [Mini PCI card](#) (if applicable) and the optical drive.
3. Remove the [hard drive](#).
4. Remove the [hinge cover](#).
5. Remove the [keyboard](#).
6. Remove the [display assembly](#).
7. Remove the [palm rest](#).
8. Remove the [video card/thermal cooling assembly](#) (if applicable).
9. Remove the three M2.5 x 5-mm screws that secures the MCH heat sink to the system board.



1	MCH heat sink
2	M2.5 x 5-mm screws (3)

Replacing the MCH Heat Sink

1. Place the MCH heat sink over the screw holes on the system board.
 2. Replace the three M2.5 x 5-mm screws that secure the MCH heat sink to the system board.
-

[Back to Contents Page](#)

PC Card Cage

Dell™ Inspiron™ 9300 Service Manual

⚠ CAUTION: Before you begin the following procedure, see the safety instructions in the *Product Information Guide*.

➡ NOTICE: To avoid electrostatic discharge, ground yourself by using a wrist grounding strap or by periodically touching an unpainted metal surface (such as the back panel) on the computer.

➡ NOTICE: To avoid damaging the system board, you must [remove the main battery](#) before you begin working inside the computer.

1. Follow the instructions in "[Before Working Inside Your Computer](#)."
2. Remove the [hard drive](#).
3. Remove the [optical drive](#).
4. Remove the [hinge cover](#).
5. Remove the [keyboard](#).
6. Remove the [display assembly](#).
7. Remove the [palm rest](#).
8. Disconnect the PC Card connector from the system board.

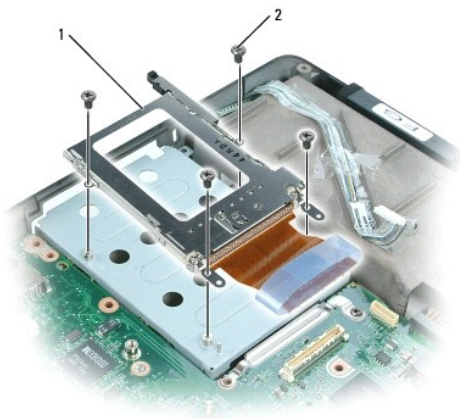

1	PC Card connector
2	M2 x 3-mm screws (4)

9. Remove the four M2 x 3-mm screws that attach the PC Card cage to the top of the hard drive bay.

System Board

Dell™ Inspiron™ 9300 Service Manual

- [Removing the System Board](#)
- [Replacing the System Board](#)

Removing the System Board

⚠ CAUTION: Before you begin the following procedure, see the safety instructions in the *Product Information Guide*.

- ➡ **NOTICE:** To avoid electrostatic discharge, ground yourself by using a wrist grounding strap or by periodically touching an unpainted metal surface (such as the back panel) on the computer.
- ➡ **NOTICE:** To avoid damaging the system board, you must [remove the main battery](#) before you begin working inside the computer.

The system board's BIOS chip contains the Service Tag, which is also visible on a barcode label on the bottom of the computer. The replacement kit for the system board includes a CD that provides a utility for transferring the Service Tag to the replacement system board.

1. Follow the instructions in "[Before Working Inside Your Computer](#)."
2. Remove the [hard drive](#).
3. Remove the [optical drive](#).
4. Remove the [memory module\(s\)](#).
5. Remove the [modem](#).
6. Disconnect the modem cable from the system board.

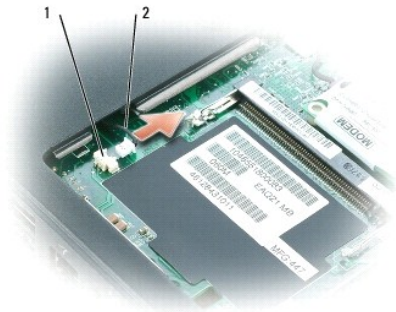

1	modem cable connector on system board
2	modem cable

7. Remove the [Mini PCI card](#).
8. Remove the [hinge cover](#).
9. Remove the [keyboard](#).
10. Remove the [display assembly](#).
11. Remove the [palm rest](#).
🔧 NOTE: It is not required but is highly recommended that you [remove the system fans](#) to allow easier access to the system board.
12. Disconnect the PC Card connector from the system board.
13. Remove the remaining M2.5 x 5-mm screw holding the stiffener bracket in place, and remove the stiffener bracket.



1	PC Card connector
2	M2.5 x 5-mm stiffener bracket screw
3	stiffener bracket
4	PC Card connector on system board

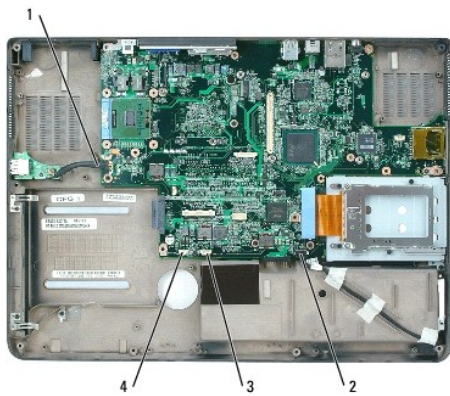

1	USB connector
2	cable connector for internal card with Bluetooth wireless technology
3	speaker connector
4	subwoofer connector

14. Disconnect the speaker connector from the system board.
15. Disconnect the connector for the internal card with Bluetooth® wireless technology from the system board.
16. Disconnect the subwoofer connector from the system board.
17. Disconnect the USB port board connector from the system board.
18. Disconnect both fan connectors from the system board.
19. Remove the [video card/thermal cooling assembly](#).

 **NOTE:** Remove the video card/thermal assembly as a single unit. Do not separate the thermal cooling unit (heat sink) from the video card.

20. Remove the MCH heat sink.
21. Remove the [microprocessor thermal-cooling assembly](#).
22. Remove the [microprocessor](#).

23. Remove the three M2.5 x 5-mm screws from the system board.



1 system board M2.5 x 5-mm screws (3)

24. Remove the system board, slowly easing the connectors out of their access holes on the back and side of the computer base:
- With the back of the computer facing you, grasp the upper-right corner of the system board and lift it slightly.
 - Pull the system board assembly away from you toward the front of the computer and slightly to the right; at the same time, use your left hand to release the audio connectors by pulling the side of the computer base slightly to the left.

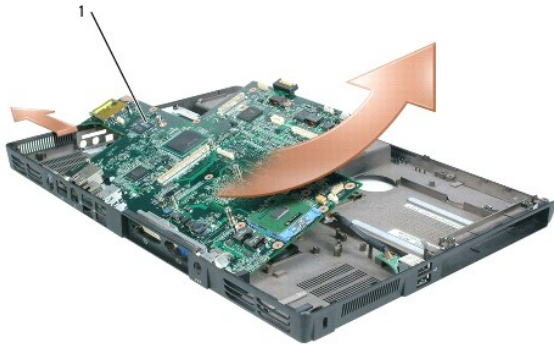

1 system board

Replacing the System Board

- Perform all of the steps in ["Removing the System Board"](#) in reverse order.

NOTICE: Before turning on the computer, replace all screws and ensure that no stray screws remain inside the computer. Failure to do so may result in damage to the computer.

- Turn on the computer.

NOTE: If you use a BIOS update program CD to flash the BIOS, press <F12> before inserting the CD so that you can set up the computer to boot from a CD this one time only. Otherwise, you must enter the system setup program to change the default boot order.

- Insert the flash BIOS update program CD that accompanied the replacement system board into the optical drive. Follow the instructions that appear on the screen. See ["Flashing the BIOS"](#) for further information.
 - Enter the system setup program to update the BIOS on the new system board with the computer Service Tag.
-

[Back to Contents Page](#)

Battery Latch Assembly

Dell™ Inspiron™ 9300 Service Manual

- [Removing the Battery Latch Assembly](#)
- [Replacing the Battery Latch Assembly](#)

Removing the Battery Latch Assembly

⚠ CAUTION: Before you begin the following procedure, see the safety instructions in the *Product Information Guide*.

🔌 NOTICE: To avoid electrostatic discharge, ground yourself by using a wrist grounding strap or by periodically touching an unpainted metal surface (such as the back panel) on the computer.

🔌 NOTICE: To avoid damaging the system board, you must [remove the main battery](#) before you begin working inside the computer.

1. Follow the instructions in "[Before Working Inside Your Computer](#)."
2. Remove the [hinge cover](#).
3. Remove the [keyboard](#).
4. Remove the [display assembly](#).
5. Remove the [palm rest](#).
6. Remove the [system board](#).
7. Remove the hard drive bay by removing the four M2 x 3-mm screws, and lifting out the bay.

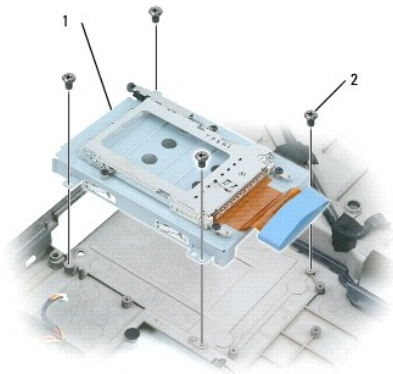

1	hard drive bay
2	M2 x 3-mm screws (4)

8. Remove the screw in the battery latch assembly.

When you remove the screw, the battery latch release on the bottom of the computer will also be removed.

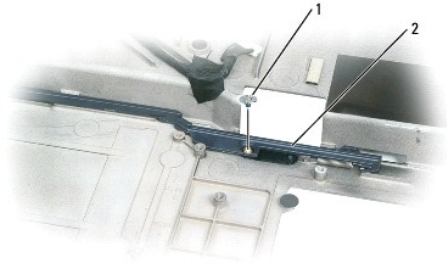

1	screw
2	battery latch assembly

9. Remove the spring from the hook on the computer base by lifting it up and away with a screwdriver or a plastic scribe.

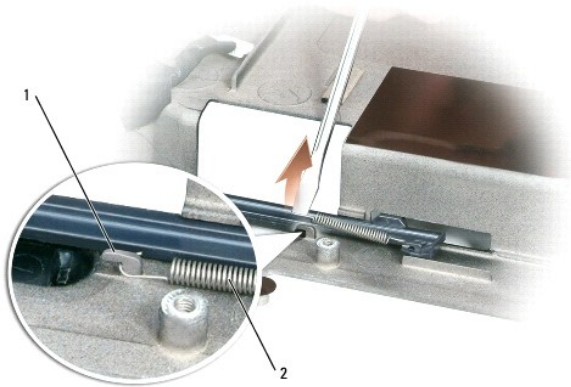

1	hook
2	spring

10. Remove the plastic battery-latch assembly by twisting the assembly slightly and lifting it out of the channel and away from the computer base.

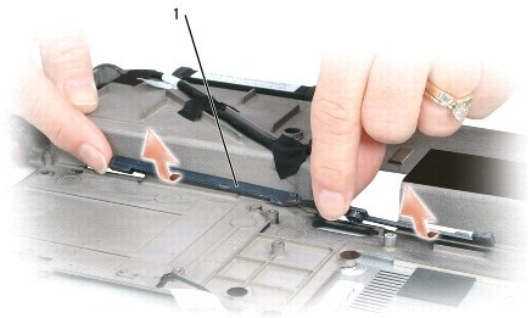

1	battery latch assembly
---	------------------------

Replacing the Battery Latch Assembly

1. Insert the latch assembly into the channel on the computer base, and press it into place.
2. Using a small screwdriver, hook the spring over the hook on the computer base.
3. Place the battery latch release under the computer base, line it up with the hole in the base, and then replace the screw in the assembly.

Ensure that the newly installed latch moves smoothly and freely when pushed and released.

4. Replace the hard drive bay and reinsert the four M2 x 3-mm screws.
5. Replace the [system board](#).
6. Replace the other components removed in "[Removing the Battery Latch Assembly](#)" in reverse order.

[Back to Contents Page](#)

Flashing the BIOS

Dell™ Inspiron™ 9300 Service Manual

 **NOTICE:** Plug the AC adapter into a known good power source to prevent a loss of power. Failure to do so may cause system damage.

1. Ensure that the AC adapter is plugged in and that the main battery is installed properly.

 **NOTE:** If you use a BIOS update program CD to flash the BIOS, press <F12> before inserting the CD so that you can set up the computer to boot from a CD this one time only. Otherwise, you must enter the system setup program to change the default boot order.

2. Insert the BIOS update program CD, and turn on the computer.

 **NOTICE:** Do not interrupt this process once it begins. Doing so may cause system damage.

Follow the instructions that appear on the screen. The computer continues to boot and updates the new BIOS. When the flash update is complete, the computer will automatically reboot.

3. Press <F2> during POST to enter the system setup program.
4. Press <Alt> and <f> to reset the computer defaults.
5. Press <Esc>, select **Save changes and reboot**, and press <Enter> to save configuration changes.
6. Remove the flash BIOS update program CD from the drive and restart the computer.

Pin Assignments for I/O Connectors

Dell™ Inspiron™ 9300 Service Manual

- [USB Connector](#)
 - [Video Connector](#)
 - [S-Video TV-Out Connector](#)
 - [IEEE 1394 Connector](#)
-

USB Connector

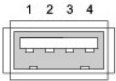

Pin	Signal
1	USB5V+
2	USBP-
3	USBP+
4	GND

Video Connector

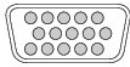

Pin	Signal	Pin	Signal
1	CRT_R	9	5V+
2	CRT_G	10	GND
3	CRT_B	11	MONITOR_DETECT-
4	NC	12	DDC_DATA
5	GND	13	CRT_HS
6	GND	14	CRT_VS
7	GND	15	DDC_CLK
8	GND		

S-Video TV-Out Connector

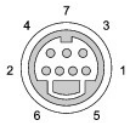

S-Video	
Pin	Signal
1	GND

2	GND
3	DLUMA-L
4	DCRMA-L

Composite Video	
Pin	Signal
5	NC
6	DCMPS-L
7	GND

IEEE 1394 Connector

1 2 3 4



Pin	Signal
1	TPB-
2	TPB+
3	TPA-
4	TPA+

[Back to Contents Page](#)